

SS741MG-11

DUAL AMPLIFIER SIREN

Installation and Operating Instructions



PROUDLY MADE IN THE USA
An ISO 9001:2008 Certified Company



Star Headlight & Lantern Co., Inc.

455 Rochester Street Avon, NY 14414 Phone: 585-226-9787 FAX: 888-478-2797

STAR
WARNING
SYSTEMS

STAR
SIGNAL
VEHICLE PRODUCTS

BRADFORD
Vehicle Solutions

www.starheadlight.com

PLITSTR250 REV F 5/15/17

Installation Information

MODEL: SS741MG-11	Serial #: _____
	OPTIONS
PURCHASE DATE: _____	_____ Alternate Magnum Tones
INSTALLATION DATE: _____	_____ Two-Tone Enabled
INSTALLER: _____	_____ Phaser/Man Auxiliary
DEALER: _____	_____ Phaser Disabled
Model and serial number located on bottom of unit	

TABLE OF CONTENTS

GENERAL DESCRIPTION	1-2
INSTALLATION	2-10
SAFETY PRECAUTIONS	2, 6
UNPACKING	2
INSTALLER-SELECTABLE OPTIONS	3-6
MOUNTING	6-7
ELECTRICAL CONNECTIONS	8-10
WIRING DIAGRAM	10
 OPERATION	 11-14
GENERAL	11
POWER	11
SELECTOR SWITCH	12
MANUAL	13
MAGNUM FUNCTION	13
HORN	13
VOLUME CONTROLS	14
AUXILIARY INPUT	14
PARK KILL	14
MICROPHONE	14
 SERVICE	 15-18
TROUBLESHOOTING	15
SPEAKER DIAGNOSTICS	16
RFI REDUCTION	16
PARTS	17
LIMITED WARRANTY	17
RETURNS	17
SPECIFICATIONS	18
CONTROL HEAD CUT-OUT INSTALLATION TEMPLATE	19

General Description

The SS741MG Remote Siren Amplifier is a premium 200W unit designed for dual 100W speaker use. It comes standard with a remote control head and a noise-cancelling microphone for PA use. The amplifier box contains two separate amplifiers that allow the user to operate two separate and distinct tones at the same time. This dual tone (Magnum) feature creates a unique sound that is one of the most attention getting amplifiers on the market today. The Magnum sound allows a single vehicle to sound like several vehicles traveling at the same time. Each amplifier operates one 100W RMS speaker and has its own fuse.

The primary operating modes are Phaser, Yelp, Wail, Hands Free, Manual, Alert, and Radio. A Noise Cancelling PA Override and push-button Horn Override are available in all modes. A manual push-button is provided for push-on/push-off tone toggle operation in the Phaser, Yelp, and Wail modes. It also allows manual siren control in the Manual, Alert or Hands Free modes. The Phaser function can be optionally replaced by Two-Tone, or disabled entirely, with program jumpers.

(General Description CONT'D)

Another feature allows cycling through Wail, Yelp, Phaser and Standby by providing a signal to the horn ring auxiliary wire when the function switch is in the Hands Free (HF) position. A Park Kill option is provided for connection to a door switch, etc. to disable the siren when exiting the vehicle. The PA volume control is provided on the front panel of the control head, while the Radio volume is on the amplifier box. The front panel is backlighted with LED's for night visibility. This compact unit utilizes short circuit, high voltage, low voltage, and reverse polarity protection systems for maximum service life.

The SS741MG unit is designed to allow maximum versatility in mounting. The control head is remote from the siren amplifier box creating a compact user interface plate that can be flush mounted into the dashboard. The amplifier box can then be mounted remotely in the trunk, under the dashboard, under the seat, or wherever convenient.

The siren amplifier has been designed with several protection features to provide exceptional field service. Excessively high or low voltage detection will disable the siren output to protect both the amplifier and the speaker. Fused inputs provide safety against reverse polarity. Speaker diagnostics provides user feedback as well as shutdown protection if the speaker output becomes either electrically open or shorted. The two separate independent amplifiers allow redundancy backup, should one speaker short out during operation the other amplifier and speaker will remain fully operational. CAUTION: These protection features will not guard against overloading the outputs.

The SS741MG unit is available in the following different versions:

- SS741MG Standard version w/ microphone mounted to the face plate.
- SS741MGX Remote microphone connected to the back of the control head via an extension harness.
- SS741MG-TEC Standard Version with reversed 7-position knob functions.

Installation Notes

Proper installation of the unit is essential for years of safe, reliable operation. Please read all instructions before installing the unit. Failure to follow these instructions can cause serious damage to the unit or vehicle and may void warranties.

Qualifications - The installer must have a firm knowledge of basic electricity, vehicle electrical systems and emergency equipment.

Keep These Instructions - Keep these instructions in the vehicle or other safe place for future reference. Advise the vehicle operator of the location.

UNPACKING

Inspect the contents for shipping damage. If found, alert the carrier immediately. Contents should include:

- (1) instruction booklet***
- (1) amplifier box***
- (1) control head with microphone***
- (1) microphone bracket w/(2) screws***
- (1) amplifier wire harness with connector***
- (1) communication cable (telephone-style cable)***
- (2) control head power wires***

Please contact your supplier immediately if any of these components are missing.

Installer Selectable Options

There are several options that can be selected during installation. Jumpers on the back of the control head, as well as on the printed circuit board inside the amplifier case, allow the installer to select these various options. These options should be set before installation of the unit.

Amplifier Cover Removal

Remove the four protruding Philips head screws located on the top of the amplifier unit, and the four flush Philips head screws on the sides of the amplifier unit. **DO NOT REMOVE THE FOUR RECESSED SCREWS ON THE UNDERSIDE OF THE AMPLIFIER!** Lift the top cover upwards. This cover can be removed completely from the amplifier unit.

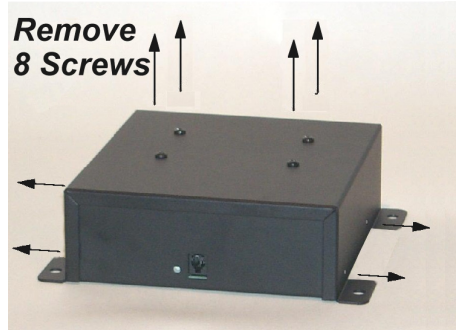

Auxiliary Input Polarity

The auxiliary input is normally activated by applying a positive voltage to the wire. If, instead, you would like to activate the auxiliary input by connecting it to ground (negative), move the "AUX" option jumper from the "Pos. Switching" pins to the "Neg. Switching" pins in the amplifier unit. (See Amplifier diagram below). The wiring diagram on page 10 shows two connection examples.

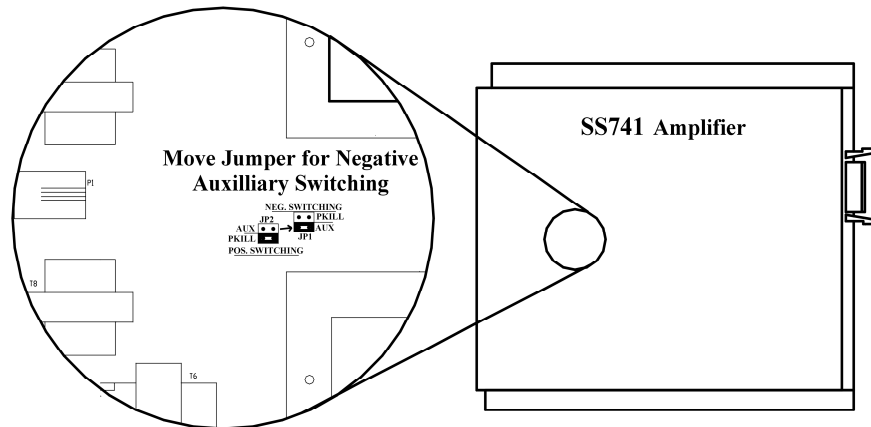

(Installer Selectable Options CONT'D)

Park Kill Input Polarity

The Park Kill (Cutout) Input turns off any siren tone output when activated, and remains off until a control is activated or changed. The wiring diagram on page 11 shows two connection examples.

The park kill input is normally activated by connecting to positive. To activate by connecting to ground (negative), move the "PKILL" option jumper from the "Pos. Switching" pins to the "Neg. Switching" pins in the amplifier unit. (See Amplifier diagram below).

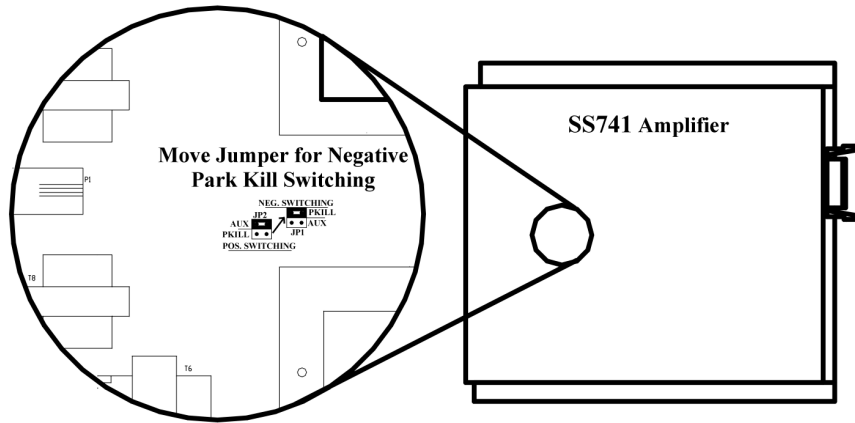

Alternate Magnum Tones

The Magnum feature allows the two speakers to either have two different siren tones at the same time, or can offset the same tone from one speaker to the other. This sound simulates two separate vehicles and allows maximum attention getting ability.

For those end users who prefer to have the Magnum feature default using two different tones every time it is utilized, and option jumper is provided on the back of the control head. To select the alternate Magnum tones, remove the first option jumper from the back of the control head. (See diagram to the right). For full description of tones, see the OPERATION section on pages 11 to 14. .

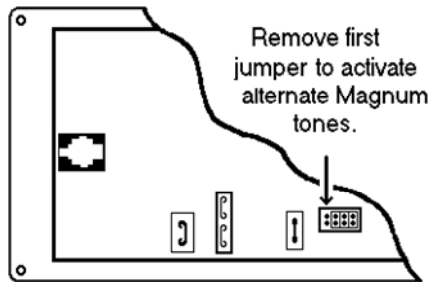

(Installer Selectable Options CONT'D)

Phaser Disable

The Phaser function can be completely disabled by removing the second option jumper from the back of the control head. This will also disable the Two-Tone function used when the manual button is pressed while the mode switch is in the Phaser position. (See diagram below).

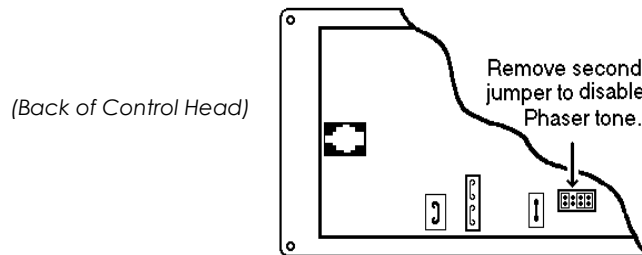

Auxiliary Input Function

The Auxiliary Input allows activation by an external source of either the Horn or the Manual push-button functions when the rotary selector switch is in the Manual, Alert, or Hands Free (HF) position. This input is usually wired into the vehicle horn switch. The wiring diagram on page 10 shows two connection examples. NOTE: Permanent disconnection of the vehicle horn is NOT recommended.

The siren is factory shipped with the auxiliary input option defaulted as the Horn function. To utilize the auxiliary input as the Manual function instead of the Horn function, remove the third option jumper from the back of the control head. (See diagram BELOW).

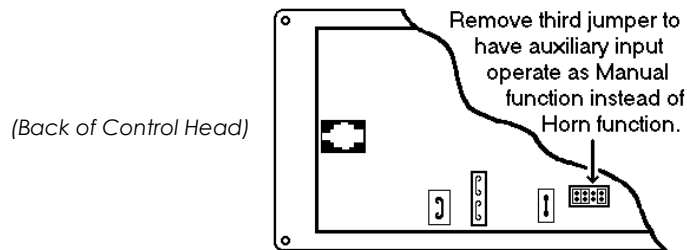

Two-Tone

Two-Tone can replace functions with Phaser by removing the fourth option jumper from the back of the control head. (See diagram below).

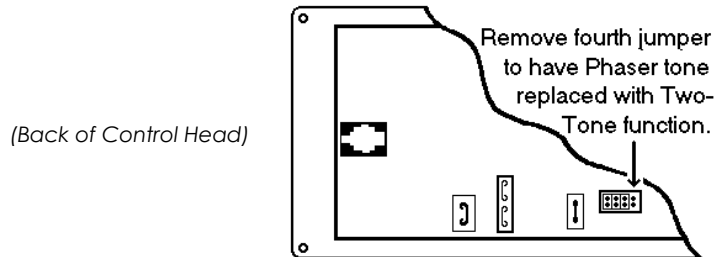

(Installer Selectable Options CONT'D)

Horn Ring Transfer

The installer may opt to have the sirens electronic air horn replace the vehicle horn. This can be done by adding a single pole, double throw (SPDT) switch. Two Horn Ring Transfer wiring diagrams are shown below.

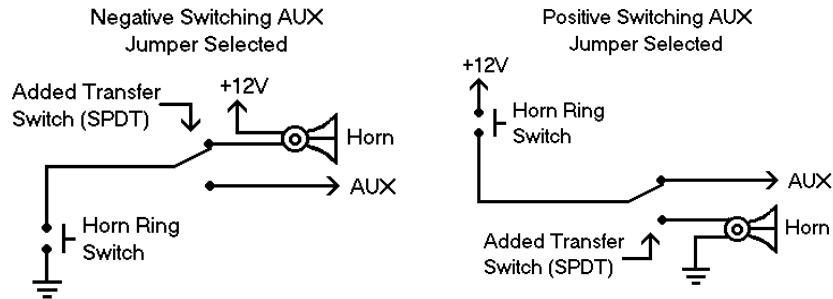

Mounting

SAFETY PRECAUTIONS

For the safety of the installer, vehicle operator, passengers and the community please observe the following safety precautions. Failure to follow all safety precautions and instructions may result in property damage, injury or death.

!!! WARNING !!!

DO NOT mount in air bag deployment area.

Devices should be mounted only in locations listed in SAE standard J1849.

Controls should be placed within convenient reach of the driver.

Assure clearances before drilling in vehicle.

Sound levels produced by attached speakers can cause permanent hearing loss.

Never operate this unit without adequate hearing protection for you and others in the area. (OSHA 1910.95)

AMPLIFIER

The amplifier should be mounted in a location such as the driver compartment firewall, under the seat, or in the trunk. It is not recommended to mount the amplifier in the engine compartment or in an area that would be allowed direct exposure to weather elements. Choose a mounting location away from any air bag deployment areas. Assure adequate ventilation to prevent overheating.

The amplifier unit is provided with a mounting flange that contains four 1/4" holes. Using the amplifier unit itself as a template, mark the location of the four mounting holes to be drilled. Be sure to check for obstructions behind the mounting hole locations. Drill the four mounting holes and secure the amplifier using appropriate hardware (not supplied). Be sure that all wiring harness connections are made prior to connecting the harness to the amplifier unit.



(Mounting CONT'D)

CONTROL HEAD



The control head is designed to be flush mounted. Select a location such as the dash, the overhead console, or a center console. Choose a mounting location convenient to the operator and away from any air bag deployment areas. Be sure to choose a location that has at least two inches of depth to accommodate the control head and cables. Consider wire routing and access to connections when selecting location as well.

Mark the mounting hole locations and the area to be cut out using the control head installation template provided on page 19. CAUTION: Use extreme caution not to oversize the cutout area. The control head will only overlap this cutout hole by 1/8" on the top and the bottom. Temporarily place the control head in the cutout opening to verify the alignment of the unit. Remove the control head and connect the communication cable and the two power cables. If the option jumpers on the back of the control head have not been previously set, refer to the Installer Selectable Options section on pages 3-6. Permanently mount the control using four #6 screws (not provided).

MICROPHONE BRACKET

A metal clip is provided for mounting the microphone. Choose a location convenient to the operator and away from any air bag deployment areas. Using the mounting clip as a template, mark the two holes to be drilled. Using a 1/8" drill bit, drill the two mounting holes. Install the two #6 screws provided with the bracket.



Electrical Connections

AMPLIFIER

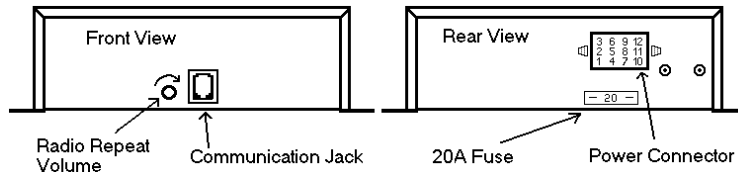

Electrical power connections to the amplifier are made using a removable connector located on the back of the amplifier case. Communication between the control head and the amplifier are made via a special communication cable. **CAUTION:** Please note that this cable IS NOT a standard telephone cord and CANNOT be replaced with one. You should make all electrical connections to the power connector before installing the connector on the unit. If the unit needs service, both the communication cable and the power connector can be easily removed without unwiring the connector.

The power supply of the unit must be capable of delivering peak currents up to 50 amps for adequate short circuit protection and reliable operation. The preferred source is directly at the vehicle battery. The unit is internally fused. A wiring diagram on the next page shows detail of how to wire the power connector on the amplifier to the vehicle. The communication cable has both ends identical, and should have one end plugged into the amplifier (RJ11 port) and the other end plugged into the control head (RJ11 port).

CONTROL HEAD

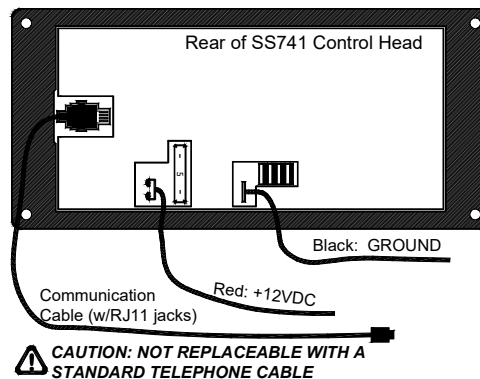

Electrical power connections to the control head are made using one male and one female spade terminal. Communication between the control head and the amplifier are made via a communication cable with an RJ11 connector. The black wire included in the kit with the female terminal should be plugged into the male spade terminal on the back of the control head. The red wire included in the kit with the male terminal should be plugged into the female terminal on the back of the control head. The communication cable has both ends identical, and should have one end plugged into the amplifier (RJ11 port) and the other end plugged into the control head (RJ11 port)

Please Note: This is NOT a standard telephone cable.

(Electrical Connections CONT'D)

Wire Size and Termination

The wiring diagram on the next page shows the minimum wire size used for each connection, along with recommended lead color. Please use the following guidelines when wiring your siren:

- If the wire is longer than 10 ft. use the next larger wire size. Use only high quality crimp connectors.
- Make sure all connections are tight.
- Route the wiring to prevent wear, overheating and/or interference with air bag deployment.
- Use grommets and sealant when passing through compartment walls.
- Minimize the number of splices to reduce voltage drop.
- Ground connections should only be made to substantial chassis components, preferably directly to the negative of the vehicle battery.
- Install and check all wiring before connection to vehicle battery.

Wiring Connections

BLACK: You MUST connect BOTH black wires when using two 100W driver speakers. Connect to the negative of the battery, or to a good chassis ground. Be sure to use minimum size #14 AWG wire.

RED: You MUST connect BOTH red wires when using two 100W driver speakers. Connect to the positive of the battery, or to a high current power buss. A power relay may also be used. Be sure to use minimum size #14 AWG wire.

BROWN: Connect to the positive terminal or lead of Speaker 1. Be sure to use minimum size #14 AWG wire.

WHITE w/ BROWN STRIPE: Connect to the negative terminal or lead of Speaker 1. Be sure to use minimum size #14 AWG wire.

Please note: The Brown and White w/Brown Stripe wire must be connected for PA and Radio Repeat)

ORANGE: Connect to the positive terminal or lead of Speaker 2. Be sure to use minimum size #14 AWG wire.

WHITE w/ ORANGE STRIPE: Connect to the negative terminal or lead of Speaker 2. Be sure to use minimum size #14 AWG wire.

You must observe the polarity of the speakers (phasing). Be sure the positive terminals of both speakers are connected to the solid brown wire and solid orange wire from the siren. The negative terminals of both speakers should be connected to the white, same color stripe, striped wires from the siren.

Optional Connections:

BLUE: Use for radio repeat. Connect one blue lead to each terminal of the radio speaker or output connector of the radio. Most radio outputs are isolated, in which polarity would not be important. Radios with polarity sensitive outputs should be connected w/ the blue wire from pin 6 to the positive radio output, and the blue wire from pin 3 to the negative radio output. Use #18 AWG wire.

GREEN: Use for remote (Aux.) Manual control. Connect to horn ring circuit or remote switch. Circuit may be positive or negative with proper jumper selection. See INSTALLER-SELECTABLE OPTIONS section (page 3) for jumper details. **NOTE:** Cut lead short if not used & insulate w/ electrical tape.

WHITE: Used for Park Kill (Cut-off). Connect to dome light or added door switch. Circuit may be positive or negative with proper jumper selection. See INSTALLER-SELECTABLE OPTION section (page 4) for jumper details. **NOTE:** Be sure to cut lead short if not used and insulate with electrical tape.

Testing - Test all siren functions after installation to assure proper operation. Test vehicle operation to assure no damage to vehicle.

(Electrical Connections CONT'D)

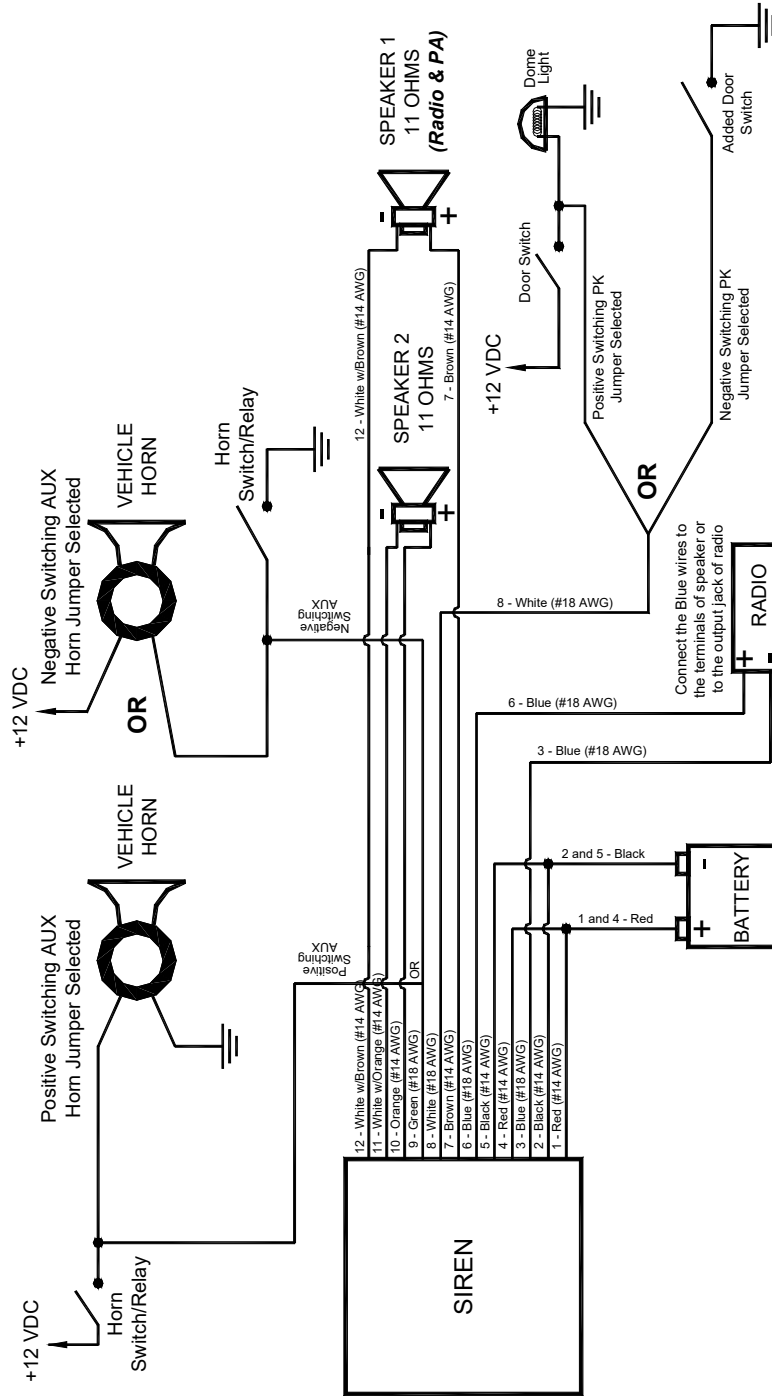

Operation

General



Please note that for the SS741MG-TEC the 7-position knob functions are reversed.

This unit is designed for easy operation under the stress associated with high-speed pursuit. Most siren functions are accessible with one simple motion without repetitive activation of switches or automatic timed switching that can interfere with desired operation.

Power

In order for the siren to function, the power switch must be in the ON position. When turned on, the siren may be activated at the operator's discretion.

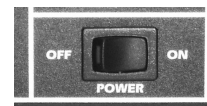

Selector Switch

The rotary selector switch controls the primary operating function of the siren.

PHSR - Ultra-fast changing tone used for maximum attention.

YELP - A rapidly changing tone used in congested areas.

WAIL - A slower changing tone used on highways.

HF - Hands Free - A silent standby mode also known as Horn Ring Cycler. Allows the user to cycle through the tones programmed for the WAIL, YELP, PHSR, and OFF by repeatedly pressing the horn or other switch connected to the AUX input. Changing the rotary knob to any other mode will resume normal siren operation.

MAN - A silent standby mode that allows push-button Manual, push-button Horn, and Public Address operation. The siren output winds down when the MAN button is released.

ALERT - A silent standby mode that allows push-button Manual, push-button Horn and Public Address operation. The siren output terminates immediately when the MAN button is released.

RADIO - Also known as Radio Repeat, this function amplifies a **two-way** radio speaker input for re-broadcast outside the vehicle through speaker #2. The PA remains functional, but no siren tones are available in this position.



Please note that for the SS741MG-TEC the 7-position knob functions are reversed.

(Operation CONT'D)

Mode vs. Output:

Rotary Switch Position:	Speaker Output Tone	Pressing the Manual Pushbutton Changes the Tone To:
Phaser	Phaser	Two-Tone
Yelp	Yelp	Phaser
Wail	Wail	Yelp
Hands Free	No Output	Creates a manual WAIL tone while button is being held that sweeps down when the button is released.
Manual	No Output	Creates a manual WAIL tone while button is being held that sweeps down when the button is released.
Alert	No Output	Creates a manual WAIL tone while button is being held that stops immediately when the button is released.

(NOTE: PHASER and TWO-TONE may be optionally swapped or disabled via program jumpers. See INSTALLER-SELECTABLE OPTIONS on pages 4-5.)

The front panel contains two momentary push-button switches for the Manual function and the Air Horn.

MAN Button

Rotary Switch
Position

Function When MAN Pressed

MAN / HF / ALERT

Produces a manually activated Wail tone. (Note: The MAN button has no effect when in HF mode and a tone is active.)

PHSR/YELP/WAIL

The MAN button will "step" the siren up to the tone programmed for the next function:

(WAIL➔YELP➔PHSR➔Phaser Step Up)

These quicker tones are used to momentarily alert motorists at intersections and very highly congested areas. Pressing the MAN button once changes to the next faster tone. Pressing the MAN button again, reverts the siren back to the original tone.



Optional configuration allows the replacement of the Phaser tone with Two-Tone, or the disabling the Phaser tone entirely. These options are selected during installation and may be governed by State or Local laws. (Refer to the INSTALLER SELECTABLE OPTIONS section on page 4).

HORN Button

Pressing the HORN button provides a simulated air-horn tone while pressed. This can be used to either replace or to supplement the normal vehicle horn and is useful at intersections. This tone will override all other siren tones..

(Operation CONT'D)

Magnum Mode:

Rotary Switch Position:	Speakers 1 / 2	Pressing Manual Pushbutton 1 / 2
Phaser	Wail/Phaser	Wail/Two-Tone
Yelp	Double Yelp (Staggered)	Yelp/Phaser
Wail	Double Wail (Staggered)	Wail/Yelp
Hands Free	No Output	Creates two staggered manual WAIL tones while button is being held that sweep down when the button is released.
Manual	No Output	Creates two staggered manual WAIL tones while button is being held that sweep down when the button is released.
Alert	No Output	Creates two staggered manual WAIL tones while button is being held that stop immediately when the button is released.

(NOTE: PHASER and TWO-TONE may be optionally swapped or disabled via program jumpers. See INSTALLER-SELECTABLE OPTIONS on page 4.)

Alternate Magnum Mode:

Rotary Switch Position:	Speakers 1 / 2	Pressing Manual Pushbutton 1 / 2
Phaser	Wail/Phaser	Wail/Two-Tone
Yelp	Yelp/Phaser	Yelp/Two-Tone
Wail	Wail/Yelp	Wail/Phaser
Hands Free	No Output	Creates two staggered manual WAIL tones while button is being held that sweep down when the button is released.
Manual	No Output	Creates two staggered manual WAIL tones while button is being held that sweep down when the button is released.
Alert	No Output	Creates two staggered manual WAIL tones while button is being held that stop immediately when the button is released.

(NOTE: PHASER and TWO-TONE may be optionally swapped or disabled via program jumpers. See INSTALLER-SELECTABLE OPTIONS on page 4.)

(Operation CONT'D)

VOLUME CONTROLS

Radio Repeat Volume

The radio repeat volume is recessed on the front face of the amplifier next to the communication jack. This should be set when the vehicle is parked. First set the volume level of the vehicle's two-way radio to its normal operating volume. Adjust the siren's rotary selector switch into the RADIO position. Insert a small, flat blade screwdriver into the RADIO volume adjustment port. Turn clockwise direction to increase the sound level.



PA Volume

The PA volume control is provided for public address volume. This is located in the upper right hand corner of the control head. It should be set when the vehicle is parked. Set the PA volume to the maximum level with no feedback (squelch).



AUXILIARY INPUT

The auxiliary input may be connected to the vehicle horn ring or other switching device. It provides the same operation as pressing the HORN button or can be programmed to function like the MAN button.

PARK KILL CUT OUT

During installation, the Park-Kill input may be connected to a door switch (see page 2). It will automatically turn off any siren tone when the door is opened. The siren tone will continue to be cut off even when the door is closed. Changing any switch or input will restore normal function.

DETACHABLE MICROPHONE (SS741MGX only)

The microphone (P/N P30232-2) can be used for public address operation. It will override any siren tone when its push-to-talk (button on the side) is pressed.

Connect the microphone to the adapter harness (SWH-40). Review the diagram below for proper pin layout. Note the ridge in the connector.

The white amp connector can then be attached to the corresponding connector on the amp.

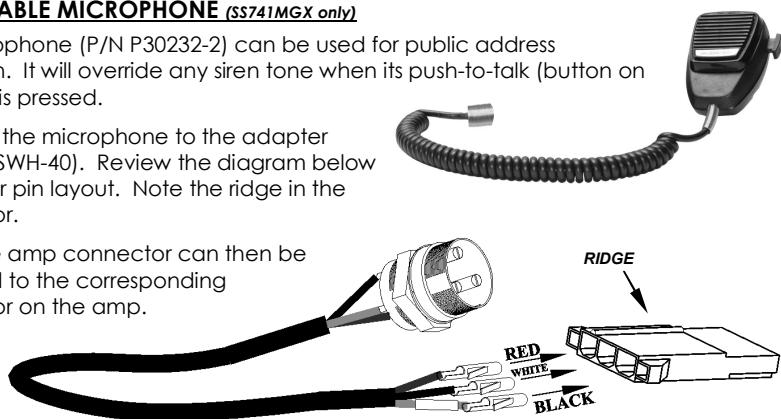

Troubleshooting

Symptom	Possible Cause	Check
No power	Power switch not turned on Connector loose Amplifier 15A fuse blown (one or both) Loose connection at power source	Does back-lighting come on? Do you hear a "pop" when turned on? Is power hooked up backwards? Positive ground vehicle? Is an external fuse or circuit breaker used? Are the negative leads connected to a good ground?
No siren tone - PA works	High voltage protection Low voltage protection Microphone button stuck Park Kill polarity option set wrong Park Kill activated	The input voltage must be less than 16 volts. The input must be greater than 10V with the siren turned on. Does microphone button release properly? Is the PK jumper option properly configured? Does the siren work when Park Kill input is disconnected?
No siren tone - No sound	Bad speaker or speaker wiring	Does either speaker diagnostic LED flash? Check for a short. Does neither speaker LED turn on steady? Check for an open.
No PA	PA volume not set properly	Have you tried turning the PA volume control?
Distorted siren sound	Speaker assembly loose Intermittent Aux. Input connection Low or high vehicle voltage	Is the speaker bell or tip loose? Is the Aux. Input used and wired properly? Input voltage must be between 10 & 16 volts while siren is on.
Intermittent siren tone	High voltage protection Low voltage protection Microphone button activation Circuit breaker in supply connection Shorted speaker or speaker wire	Is the vehicle voltage regulator working properly? Is the connector tight on the back of the unit? Is there a loose connection on a power lead? The input must be greater than 10V with the siren turned on. Is something lying on the microphone? Is a circuit breaker used with at least a 50A rating? Does the speaker have water damage, or is a wire pinched?
Horn function or Manual function stuck on	Horn switch stuck MAN push-button switch stuck Aux. Input improperly connected Aux. Input Polarity Option set wrong	Does the horn switch return fully when released? Does the MAN push-button switch return fully when released? Is the AUX Input used and wired properly? Is the AUX jumper option properly configured?
No Radio	Unit not connected to radio Radio volume too low	Is the radio connected properly to the unit? Can you hear the radio in the vehicle? Have you tried turning the Radio volume control?
No or Low Radio	Radio outputs not isolated and polarity hooked up backwards	Are the radio wires connected to the correct polarity from the radio output?
Wrong siren tone	Two-Tone option jumper installed Aux. Input set to wrong function Alternate Magnum jumper installed	Is the TT jumper option properly configured? Is the AUX jumper option configured properly? Is the Alternate Magnum tone jumper configured properly?
Phaser not working	Phaser disabled	Is the PD jumper option configured properly?

(Troubleshooting CONT'D)

Speaker Diagnostics

There are two diagnostic LED's located in the lower left hand corner of the control head. These LED's will only turn on while a tone is trying to be generated. Status of the speakers are indicated as follows:

- Steady - Speaker is connected and operating properly.
- Flashing - There is an electrical short in the speaker or wires to the speaker.
- Off - No speaker is connected, or
 - The siren is not activated to output a tone to the speaker, or
 - The speaker or wire connection is loose or is electrically open



RFI Interference

1. Make sure that both the control head and amp are securely attached to good chassis ground (i.e. no paint in-between the chassis and the grounding terminal).
2. Keep the siren control head and the police radio as far away from one another as is practical.
3. Check that the police radio antenna wire makes a right angle from the back of the police radio and runs on one side of the vehicle. The communications cable for the siren should make a right angle out of the back of the control head and exit in the opposite direction from both the police radio antenna wire and the police radio power wires.
4. Excess communication cable from the control head to the amp should be tightly bound back near the amplifier box.
5. An RFI choke (www.digikey.com P/N: 240-2066; STAR P/N: P30039-57) can be placed around the communications cable at the back of the siren amplifier box.
6. You can also place a second RFI choke around the Red and Black wires exiting the siren amplifier box.

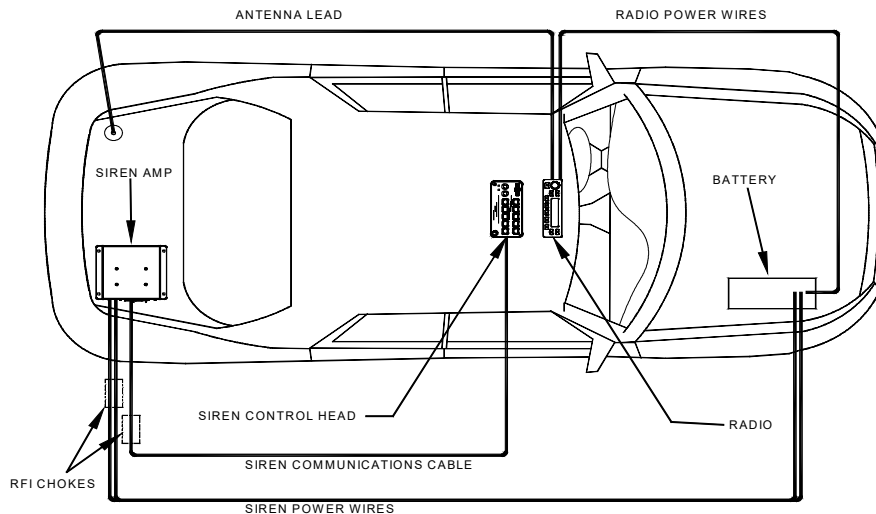

Specifications

Input Voltage	10 - 16 VDC (negative ground)
Input Current	16 Amps @ 13.6 VDC (dual 100W speakers)
Standby Current	Less than 150 mA
Audio Frequency	200Hz - 10 kHz ± 3db
Audio Output	40 watts @13.6 VDC (single 100W speaker)
Output Power	105 WATTS RMS MAX. (15.0 VDC - single 100W speaker) 210 WATTS RMS MAX. (15.0 VDC - dual 100W speakers)
Siren Frequency	675Hz - 1633Hz
High Voltage Protection	16 - 18 VDC will cause siren output to cease, resume at normal
Short Circuit Current	50 AMPS (supply circuit must be capable of supplying this)
Operating Temperature	-15° F to +140°F
Controls	7-position rotary switch (Radio, Alert, Man, HF, Wail, Yelp, Phsr) Momentary push-button Horn switch Momentary push-button Manual/Toggle switch Magnum feature (two separate tones at the same time) Auxiliary input connection for remote Manual or Hands Free operation -jumper programmable for positive or negative horn Park Kill input connection -jumper programmable for positive or negative activation Phaser (and Two-Tone) disable (jumper programmable) Two-Tone activation swaps modes with Phaser (jumper programmable) Alternate Magnum tones (jumper programmable)
Diagnostic Indicators	Two LED indicators provide diagnostic feedback, one for each speaker.
Connections (12-Pin Connector)	Detachable, 12-pin, positive locking connector with pigtail leads for Amplifier. (2) Positive, (2) Negative, (4) Speaker, (2) Radio, Auxiliary, Park Kill, Horn Telephone style communication cable between Control Head and Amplifier Power wires with Fast-On spade terminals for Control Head power.
Size	Amplifier: 2-1/2" High, 7" Wide, 7-3/8" Deep (plus 3/4" flange on each side) Control Head Face Plate: 2-7/8" High, 6-1/4" Wide, 1-1/2" Deep Control Head Mounting Hole: 2-5/8" High, 5-1/4" Wide, 2" Deep
Boxed Weight	8.3 lbs.

Service

Parts

Part	Description
P30235-4	Siren Top Cover
P30234-4	Siren Bottom Mounting Plate
SWH-31	Wiring Harness
P30069-38	Microphone Bracket with Screws
P30053-31	Amplifier Case Screws
P30028-8	5 Amp Automotive Blade Fuse for Control Head
P30028-6	15 Amp Automotive Blade Fuse for Amplifier
P30232-1	Noise Cancelling Microphone
P30208-10	Microphone Strain Relief
P30032-8	TIP36C Power Transistor
P30239-1	Rotary Selector Switch Knob
P30239-2	PA Volume Knob
P30148-8	Communications Cable*

* **CAUTION:** This is not a standard telephone cable and **CANNOT** be replaced with one.

ONE YEAR LIMITED WARRANTY

The manufacturer warrants each new product against factory defects in material and workmanship for one year after the date of purchase. The owner will be responsible for returning to the Service Center any defective item(s) with the transportation costs prepaid. The manufacturer will, without charge, repair or replace *at its option*, products, or part(s), which its inspection determines to be defective. Repaired or replacement item(s) will be returned to the purchaser with transportation costs prepaid from the service point. A copy of the purchaser's receipt must be returned with the defective item(s) in order to qualify for the warranty coverage. Exclusions from this warranty include, but are not limited to, bulbs, strobe tubes, domes, and/or the finish. This warranty shall not apply to any light, which has been altered, such that in the manufacturer's judgment, the performance or reliability has been affected, or if any damage has resulted from abnormal use or service.

There are no warranties expressed or implied (including any warranty of merchantability or fitness), which extend this warranty period. **The loss of use of the product, loss of time, inconvenience, commercial loss or consequential damages, including costs of any labor, are not covered.** The manufacturer reserves the right to change the design of the product without assuming any obligation to modify any product previously manufactured.

This warranty gives you specific legal rights. You might also have additional rights that may vary from state to state. Some states do not allow limitations on how long an implied warranty lasts. Some states do not allow the exclusion or limitation of incidental or consequential damages. Therefore, the above limitation(s) or exclusion(s) may not apply to you.

If you have any questions concerning this or any other product, please contact our **Customer Service Department** at (585) 226-9787.

If a product must be returned for any reason, please contact our Customer Service Department to obtain a Returned Materials Authorization number (RMA #) before you ship the product back.

Please write the RMA # clearly on the package near the mailing label.



PROUDLY MADE IN THE USA
An ISO 9001:2008 Certified Company

NOTICE

Due to continuous product improvements, we must reserve the right to change any specifications and information, contained in this manual at any time without notice. Signal Vehicle Products and/or the manufacturer make no warranty of any kind with regard to this manual, including, but not limited to, the implied warranties of merchantability and fitness for a particular purpose. Signal Vehicle Products and/or the manufacturer shall not be liable for errors contained herein or for incidental or consequential damages in connection with the furnishing, performance, or use of this manual.



Star Headlight & Lantern Co., Inc.

455 Rochester Street Avon, NY 14414 Phone: 585-226-9787 FAX: 888-478-2797

STAR
WARNING
SYSTEMS

STARSIGNAL
VEHICLE PRODUCTS

BRADFORD
Vehicle Solutions

www.starheadlight.com



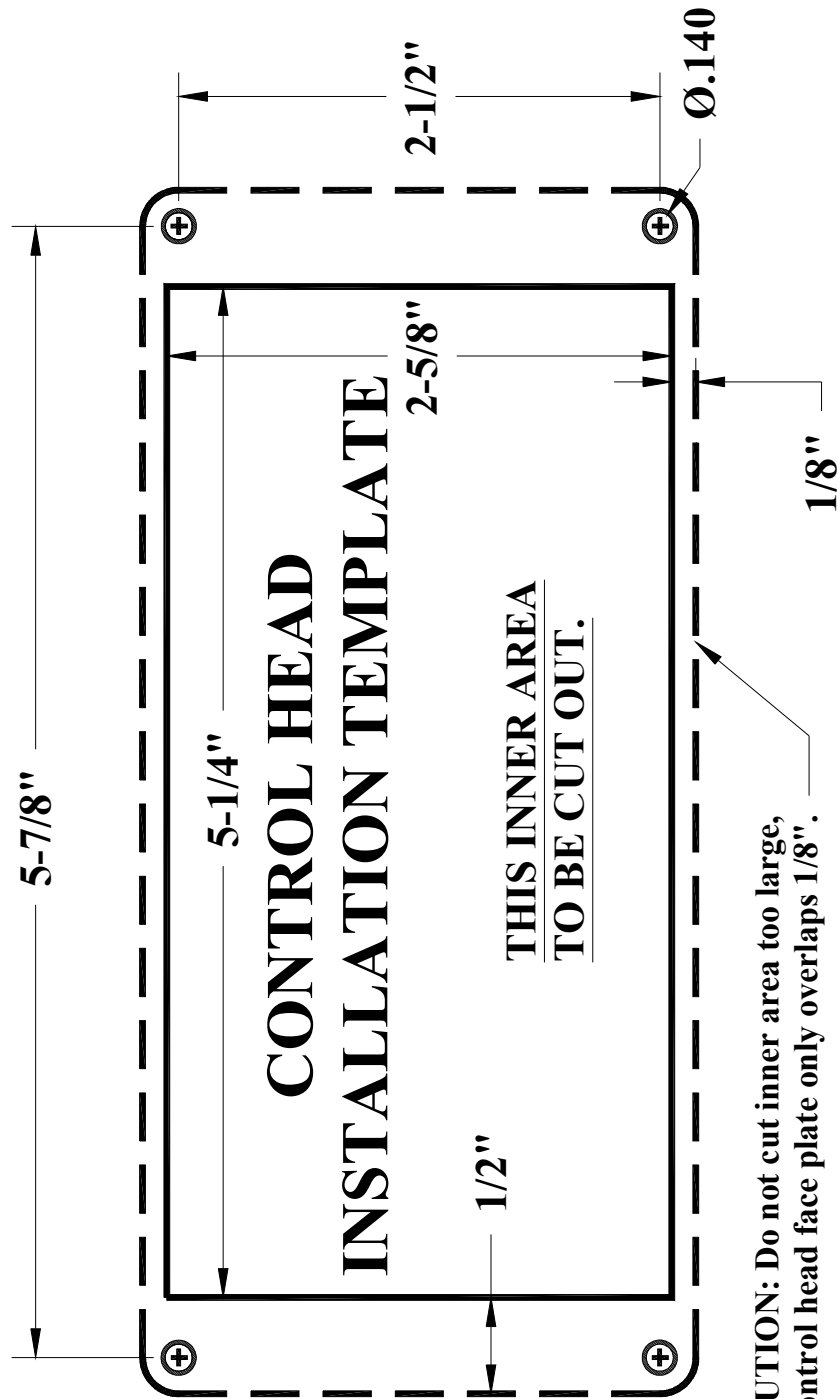

CAUTION: Do not cut inner area too large, control head face plate only overlaps 1/8".